



CreatBot 3D Printer

User manual

English V7.3

CONTENTS

Notice	3	Model Mirror	22
Machine Diagram		View Mode	23
Front	4	Right Click on Model	24
New Printer Head	5	Toolpath Structure	24
Printer Operation		Basic Setting	25
Leveling Platform	6	Advanced Setting	26
Paving Crepe Paper	6	Expert Setting	27
Load Filament	7	Skirt/Brim/Raft	28
Unload Filament	8	Plugins	28
Main menu	9	Start/End GCode	29
Status page	10	Dual Head Printing	29
Detail page	11	Align Dual Head Horizon	30
Printing page	12	Align Dual Head Vertical	31
Axis operation	13	Add Multi Type Printer	31
Filament menu	14	Using skills	
SD Card/U-disk	15	Installation section	32
Setting menu	16	Software	33
Info. menu	16	Change filament	33
Software Operation		Frequently Asked Questions	
CreatWare Setup	18	Paving Kapton	34
Quick Print UI	19	Change Fuse	35
Print Your First Model	19	Adjust Z Limit	35
Full Setting UI	20	Print PLA and ABS	35
Mouse Operation	21	Specifications	36
Model Rotate/Scale	21		

Icon conventions



Tip icon to remind users to have a good method or technique.



Note icon, to remind the user must be given adequate attention.



Prohibition icons, prevents users from unauthorized operation.

Notice

Read First

Thank you for choosing CreatBot 3D printer!

This manual contains important information about the installation, use, maintenance and common problems of CreatBot 3D printer. Please read this manual carefully before using 3D printer. All losses caused by the breach of the notes and the operation process of the operation process will be borne by the user. Please use the filament provided by CreatBot, or high quality filament by third manufacturers. Due to the use of third party inferior material caused by the failure of the printer, the loss will be borne by the user.

Software running environment, 2G or above processors, at least 1G memory, compatible with Windows, MAC, or Linux, please use memory as much as possible.

I wish you have fun with CreatBot 3D printer!

Danger Warning



The nozzle's temperature will reach 300 degrees, don't touch.



The platform's temperature will reach 120 degrees, don't touch.



Please make sure that the printer connected to the ground.



Do not attempt to open the case, be careful of electric shock.

Working Environment



The 3D printer can work in the indoor environment of 5 °C to 30 °C.



Long-term not use of the printer, be sure to keep off dust, moisture.



Long-term not use of the filament, please be sealed to prevent deterioration.

Machine Diagram

Front

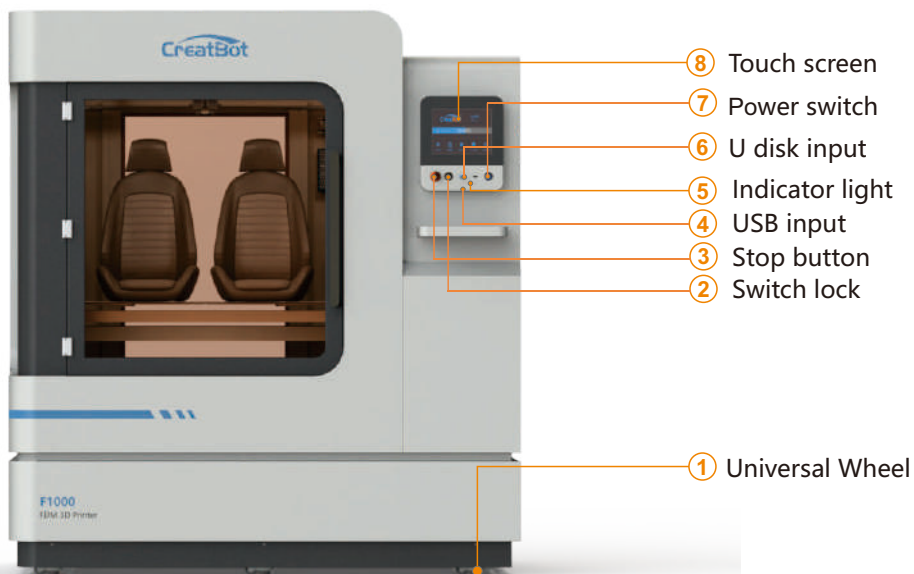

Machine Diagram

New Printer Head

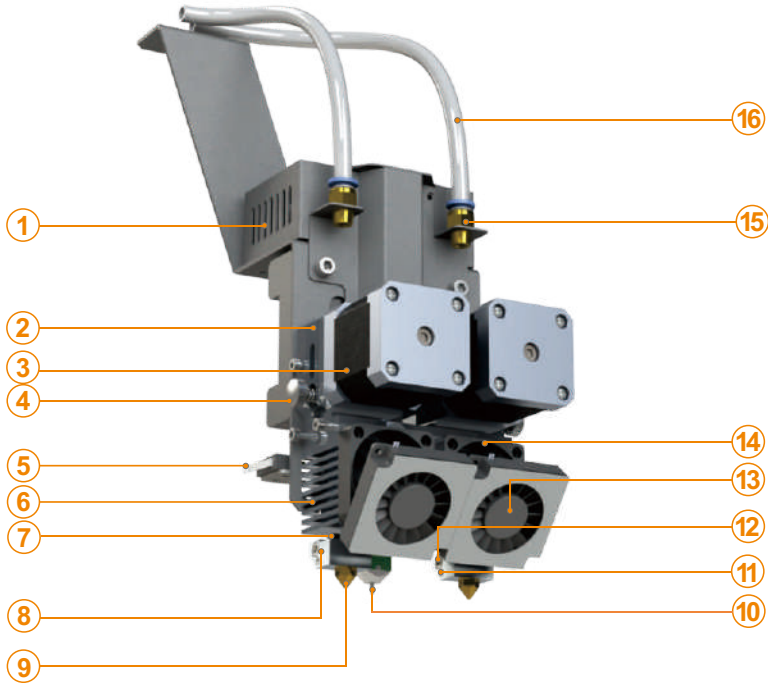

- 1. PCB box
- 2. Extruder box
- 3. Extruder motor
- 4. Filament press button
- 5. X limited switch

- 6. Heat sink
- 7. Heatbreak
- 8. Heat block
- 9. Nozzle
- 10. Bltouch
- 11. Thermistor

- 12. Heating tube
- 13. Cooling fan
- 14. Cooling fan
- 15. Connector
- 16. Feeding tube

Machine Diagram

F1000 Has three new features

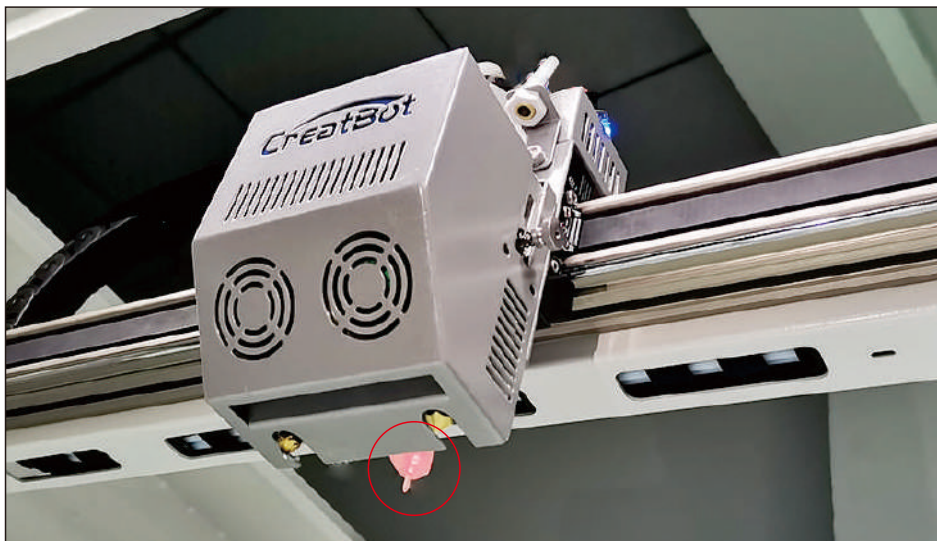

Auto leveling system
Auto-leveling working plate make leveling easily



Hot Chamber system can make inside temperature up to 60 degree.



Filament dry room have 2 temperature options to set. (45 degree /65 degree.)
Note: The PLA,PVA,HIP filaments are disable the drying function of the consumables bin.

Printer Operation

Leveling Platform

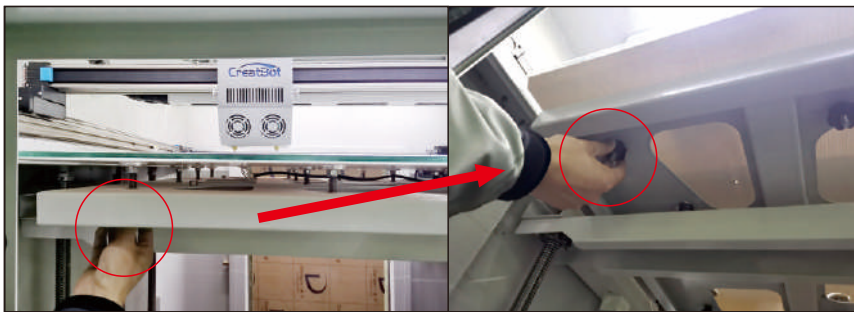
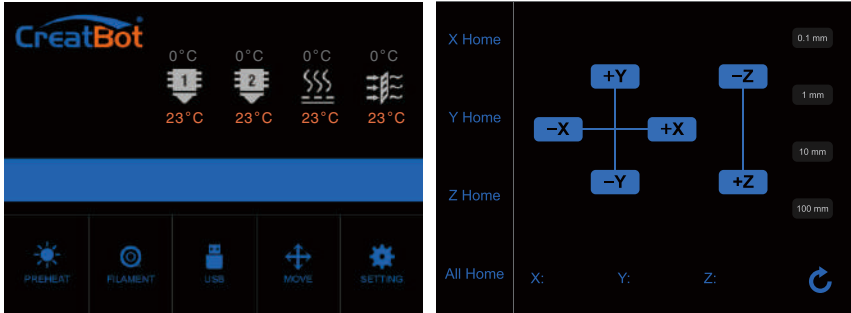

How to levelling the bed for the first time?

The entire platform consists of beams, brackets and four glass platforms.

I Leveling platform manually

1. Turn on the printer.
2. On touch screen, press “Move axis” -> “All home” to return the axis XYZ to zero.
3. Then press “-Z” until the “ Z ” value become 0 and the nozzle go near to the platform.
4. Adjust the 4 nuts under the beam so that the bracket is in a horizontal position parallel to the beam.
5. Move the extruder by hand to 4 corners and center of bed. During this movement, tighten or loosen 4 black nuts below the bed to make sure the distance between nozzle and bed is 0.05mm -0.1mm around. (Approximately the thickness of one piece of paper)
6. Repeat above movement process several times and finally adjust the platform so that each platform is positioned horizontally relative to the X/Y plane. Leveling the 4 glass platform in return.

II Auto leveling

- 1 Go to "Settings "--" auto leveling "--" Probe on the screen. Wait for the Probe to complete.
2. Enter "setting" -- "Z home" on the screen, confirm the height of Z platform is 0 on the status page, and Observe the distance between the nozzle and the platform.
3. Z offset (Servo Z offset) is in the automatic leveling menu option. If the nozzle is too far away from the platform, increase the Z offset value (0.1mm each time); If the nozzle is too close to the platform or even touches the platform, reduce the Z offset value (decrease by 0.1mm each time).
4. Probe need to be redone once you increased or decreased the Z offset.

Printer Operation

Load Filament

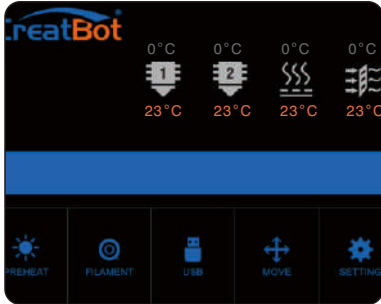

Preheat head

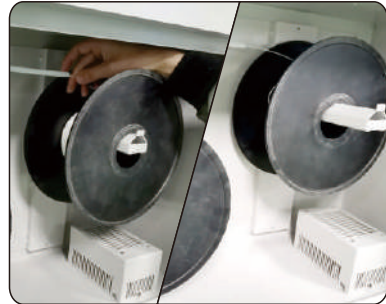

Straightened filament



Load filament



Tighten the nut

- 1.Preheat the hotend before loading filament.
- 2.Straightened filament and check the filament do not self-winding.
- 3.load filament,and fix it on the filament shelf.
- 4.load the filament until filament beyond quick fitting. Insert filament to extruder hole manually and through it until melted and flowing naturally.(Or choose extrude filament on touch screen).
- 5.Tighten the compression nut, tightness appropriately. Do same like the photo in red area. (Do not overtight, otherwise filament will be cut off.)



Notice: Pressed filament too tight or too loose will affect normal wire feeding.

Printer Operation

Unload/Change Filament

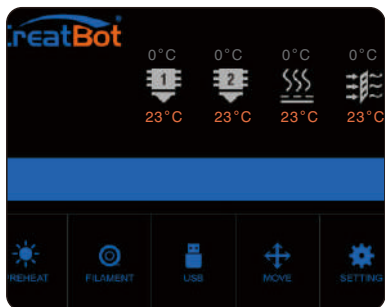

Unload filament menu

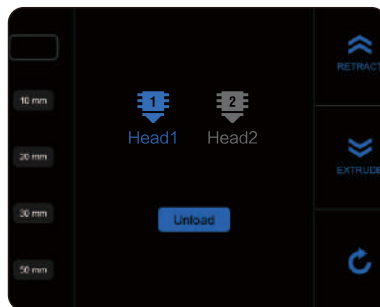

Preheat head

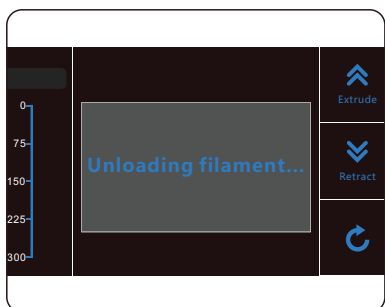

Unloading filament



Pull out filament

1. Enter "Filament" menu -> "Unload filament", and select the head you want unload.
2. Wait for the nozzle heated to a suitable temperature.
3. After reaching temperature, feeder will send a certain number of filament, and then automatically withdraw filament.
4. To manually unload filament, same as above mentioned.

Printer Operation

Touchscreen

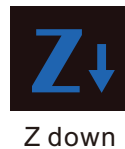
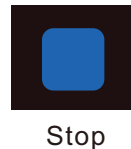
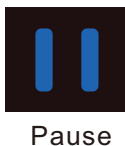
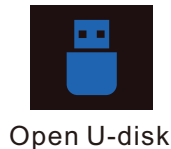
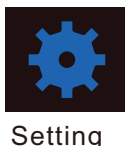
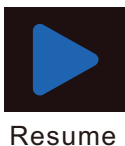
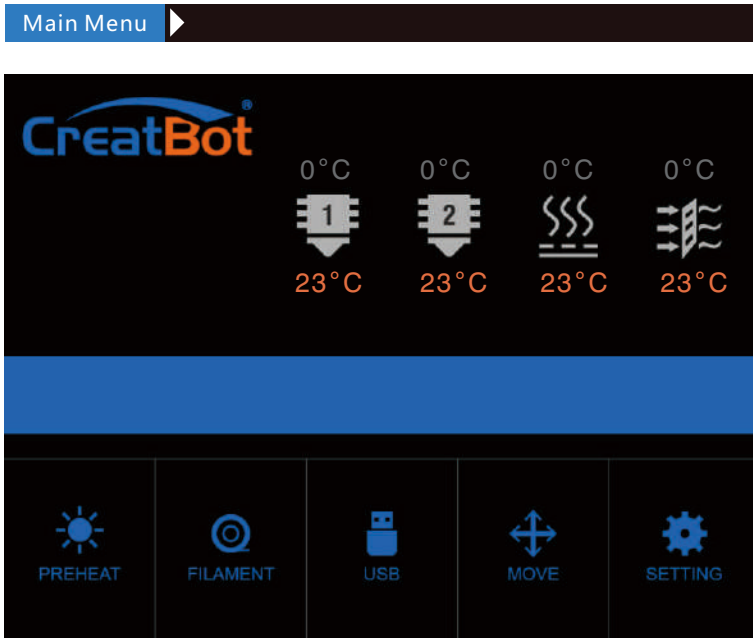

Printer Operation

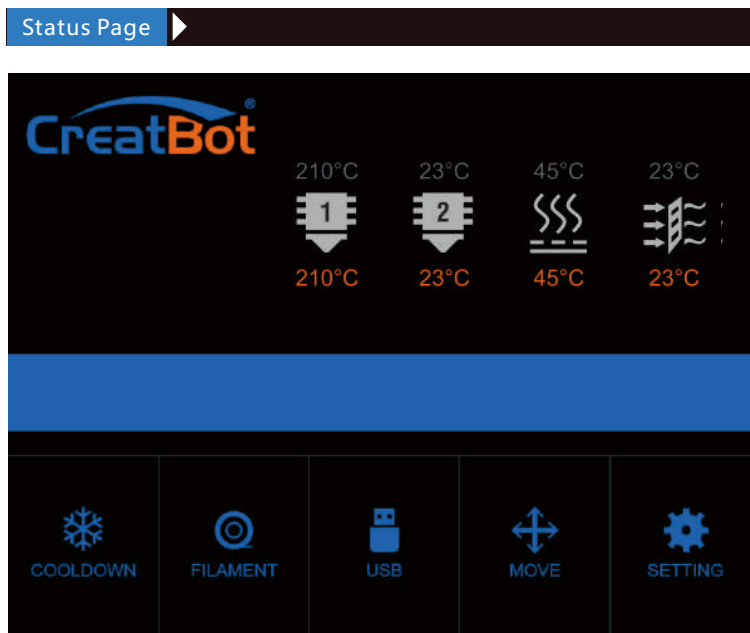

Touch and set up the temp of the nozzle.

210°C Preset nozzle temperature

210°C Current nozzle temperature



Touch and set up the temp of the nozzle.

45°C Preset nozzle temperature

40°C Current nozzle temperature



Touch and set up the temp of the hotbed.

210°C Preset platform temperature

200°C Current platform temperature



Touch and set up the temp of the hot wind.

45°C Preset hot air temperature

40°C Current hot air temperature

Printer Operation

Detail page ▶

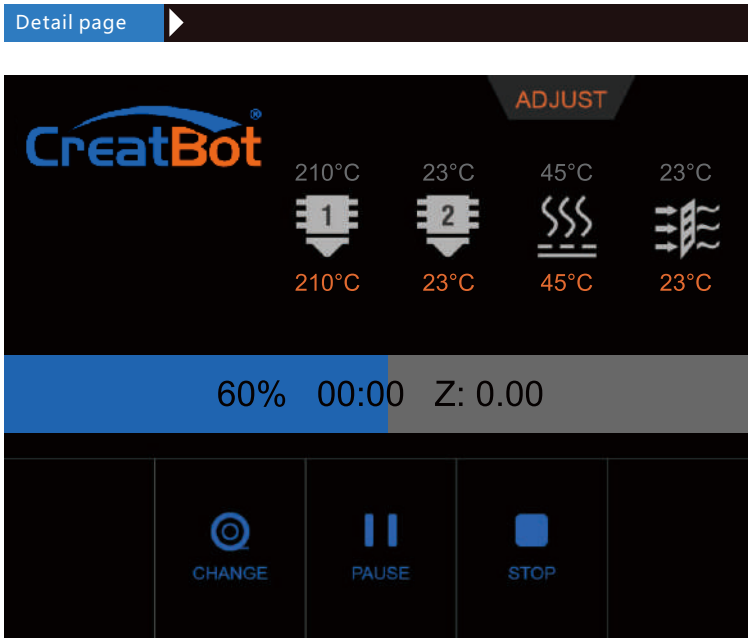

210°C 23°C 45°C 23°C

210°C 23°C 45°C 23°C

60% 00:00 Z: 0.00

CHANGE PAUSE STOP

60.00% 00:00 Z:0.00 Current printing progress



Change Pause Stop

Printer Operation

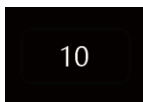
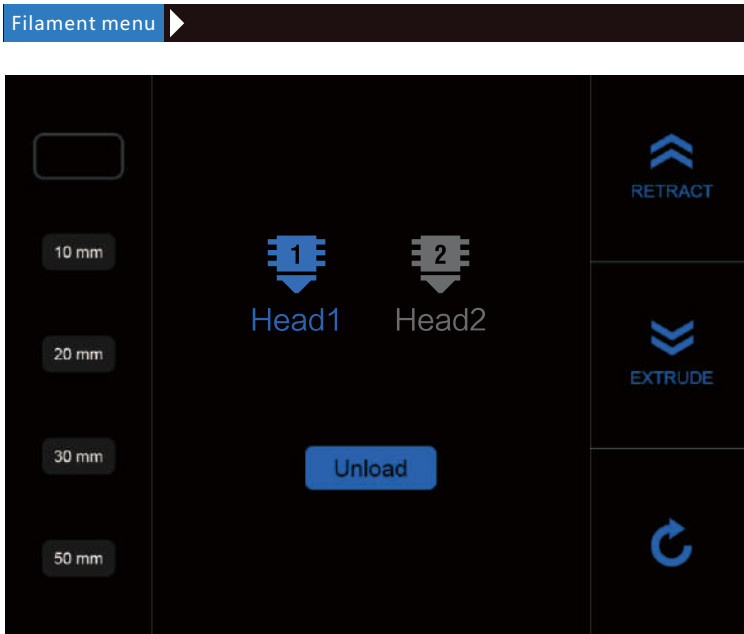

Click and enter a value

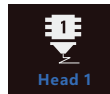

#1 extruder



Adjust value when extrude/retract filament



#2 extruder (unavailable)

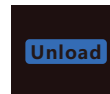

Retract filament



Extrude filament



Retract filament



Back

Printer Operation

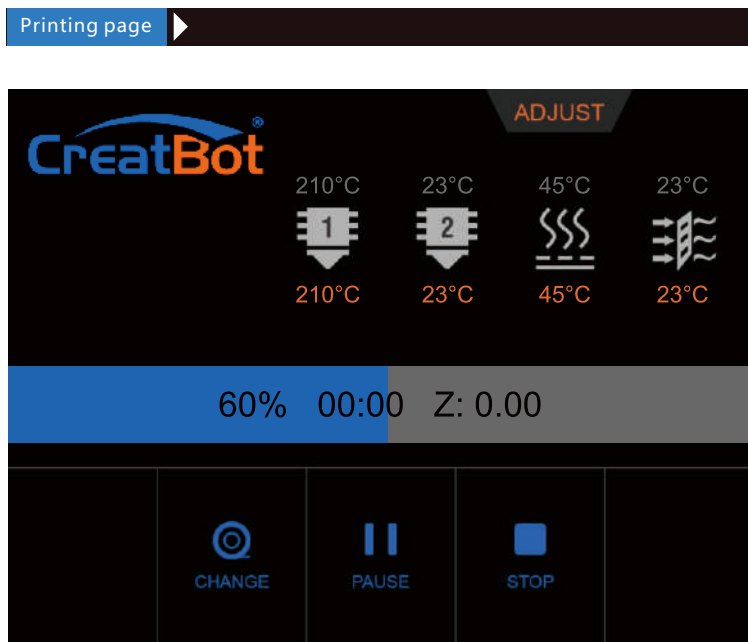

60.00% 00:00 Z:0.00 Current printing progress



Pause and Change filament.



Cancel print



Pause print

Printer Operation

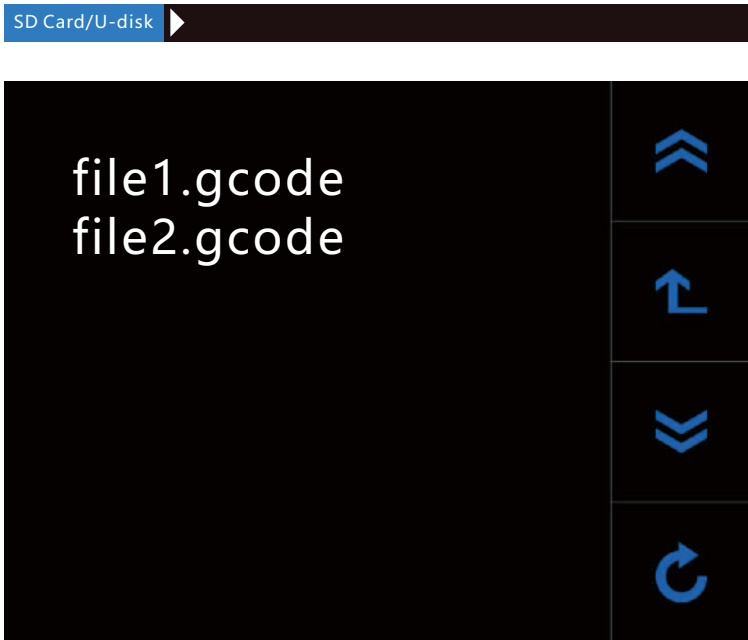

file1.gcode
file2.gcode

Click and choose a file to print



Last page



Next page



Superior menu



Back



Printer Operation

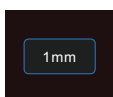
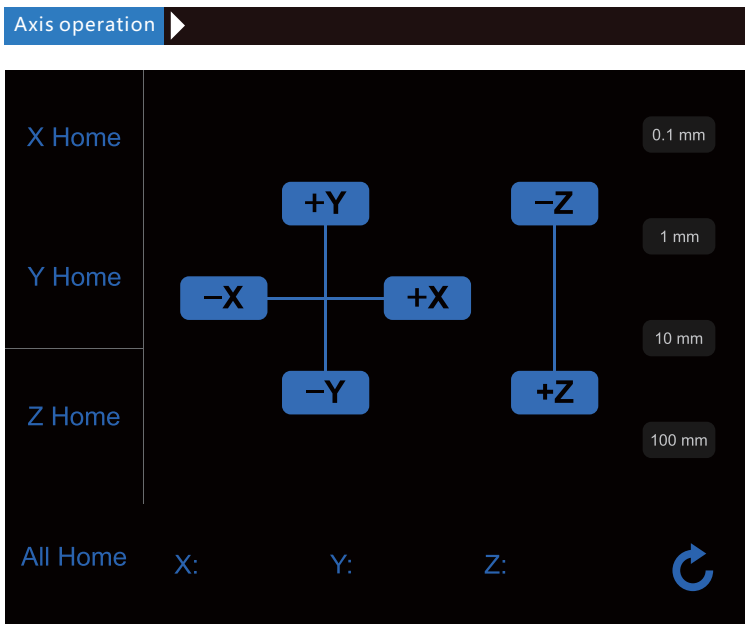

Minimum units

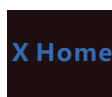

Move X to home



Move X/Y axis



Move Y to home



Z up

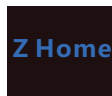

Move Z to home



Z down

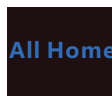

All axis to home

X:00.00
Y:00.00
Z:00.00

X,Y,Z current position of hotend.



Back

Printer Operation

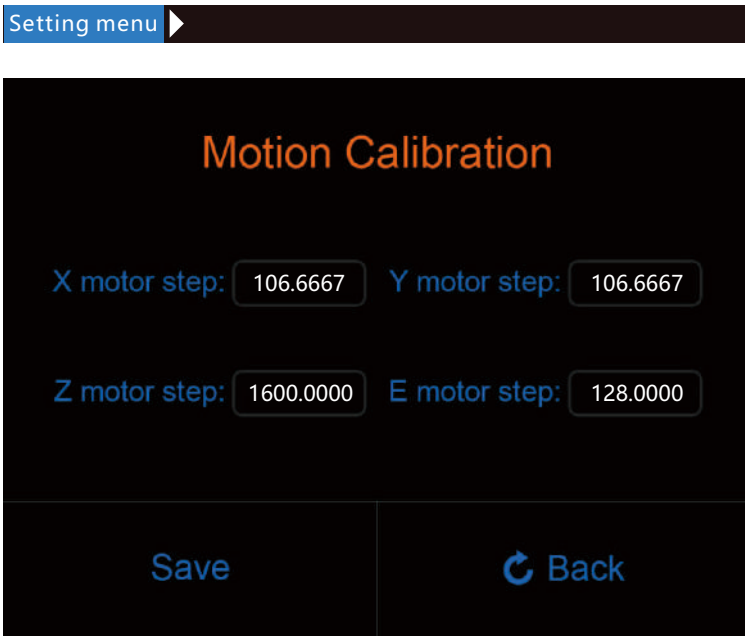

X step: 106.6667 **Z step:** 106.6667 X/Y/Z and extruder motor
Y step: 1600.0000 **E step:** 128.0000 setting (range:5-9999)



Printer Operation

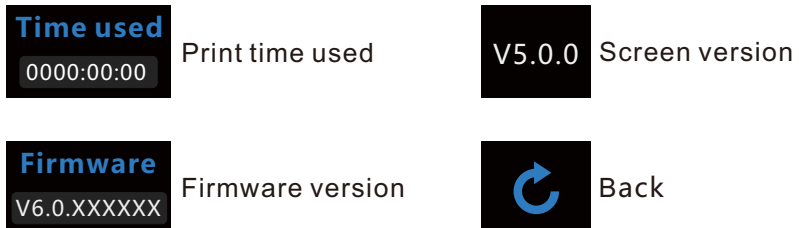
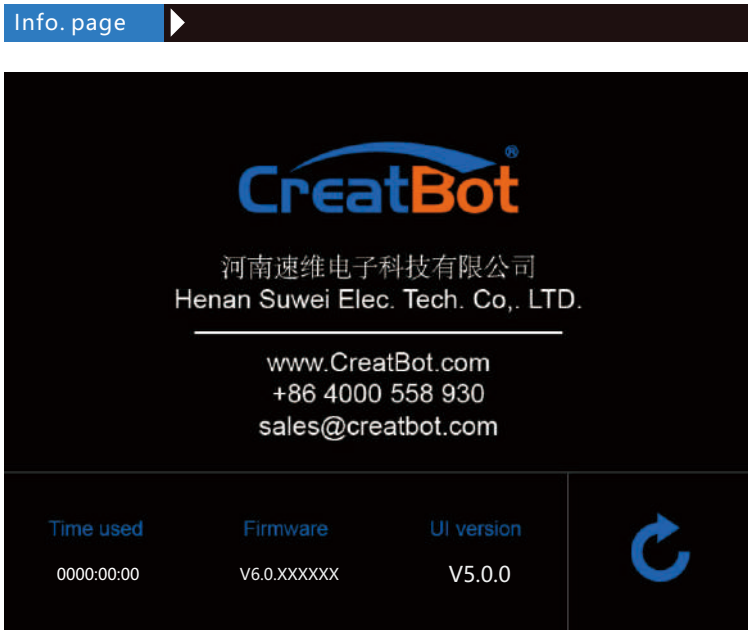

Software Operation

Creaware Setup

Download Creaware installation package from the CD-ROM or www.Creabot.com, follow the prompts to install the software, try using the default installation path as well.

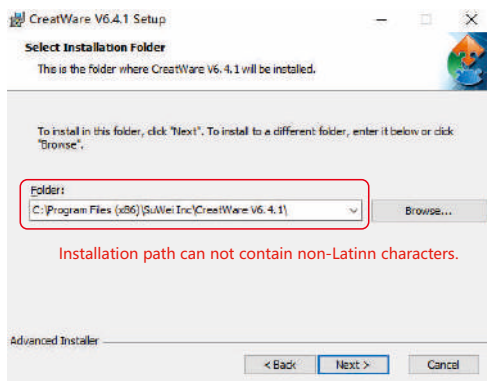
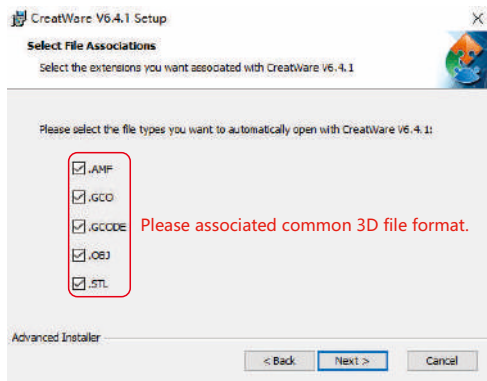

Please associated common 3D file format.

When there is a driver digital signature, please choose to agree. When finished the driver folder will locate at installation directory.

The software will select the correct language according to your OS, please select the right machine type and number of nozzles and ignore the other option and guide.

Software Operation

Quick Print UI



When insert U-disk, the toolpath will saved to the U-disk.

The file name can not contain non-Latinn characters.

Print Your First Model

Insert U-disk to the card reader, open the CreatWare, load 3D model file[1], choose correct filament and option [2], finally click save button[3], you can now finish slice model.

Insert U-disk to the printer, browse and select the Gcode file you just saved, the printer will automatically start to heating, when the temperature reaches, the printing will start.

Software Operation

Mouse Operation

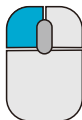

Left click

Select model, hold and move to change position, double-click to load 3D models.



Right click

Hold and move to rotate the viewpoint around the 3D model.



Left + Right

Hold and move the mouse to zoom.

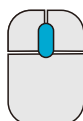

Scrollwheel

Use the scroll wheel to zoom in or out.



Left + Shift

Click and drag in rotary model can according to each 1 degree angle.

Shift



Right + Shift

Hold and move the mouse to pan the 3D view.

Shift

Keyboard Shortcut

Ctrl+L Load model/Picture

Ctrl+S Save model as

Delete Remove model

F5 Refresh view area

Ctrl+E Export setting

Ctrl+, Preferences

Software Operation

Full Setting UI

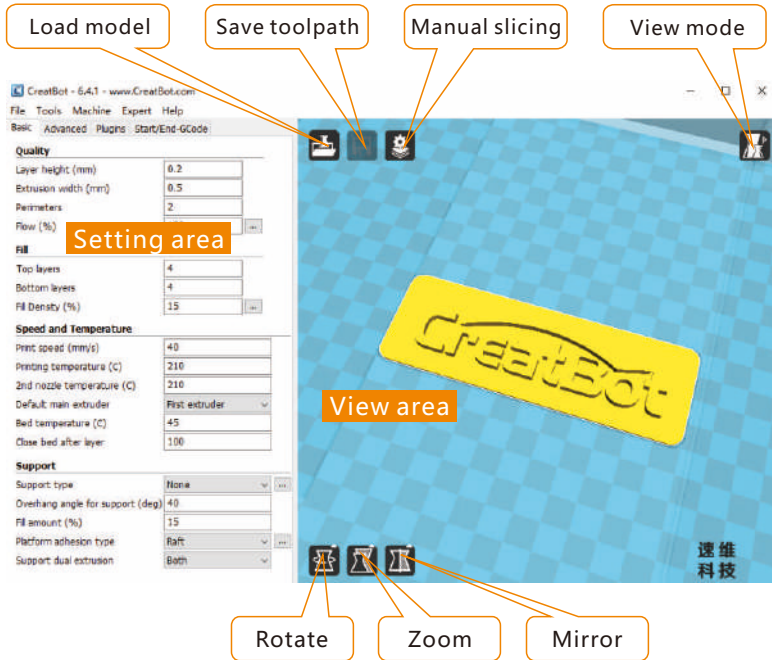

As you can see from the complete UI, the left side of the software is setting area, the right side is view area. The setting area contain "Basic", "Advanced", "Plugins", "Start/End GCode" four tabs. The Basic tab is the most common settings, usually the most frequently used parameters are here. Each parameter has a mouse-over tips, you can set parameters according the prompt. If you want to restore the default settings, please click on the menu "Tools"-> "Restore Default".



*Tip: Double-click view area can quickly load 3D model file.
The view mode and edit icon will appear when you select the 3D mode.*

Software Operation

Model Mirror

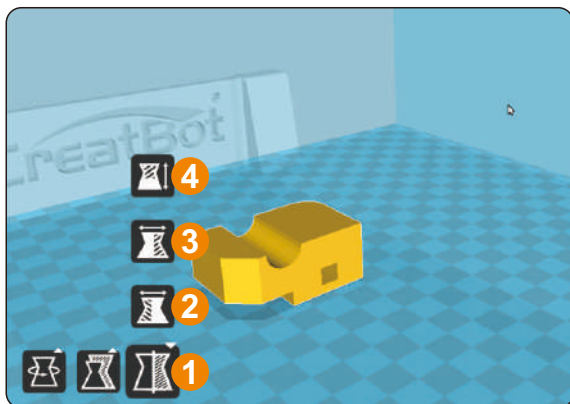

Click the mirror button [1], you can pop up the mirror menu.

Button [2] is a mirror along the X axis.

Button [3] is a mirror along the Y axis.

Button [4] is a mirror along the Z axis.

Note that the mirror transformation is different from the rotation, such as the mirror transformation will lead to a change in the direction of rotation, and the rotation will not change the model.

View Mode

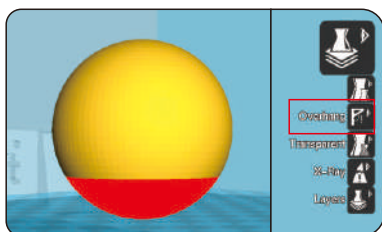

From the overhang view, you can see the suspended part of the model which is shown in red color. By changing the supporting angle can be seen suspended parts size is dynamically changing.

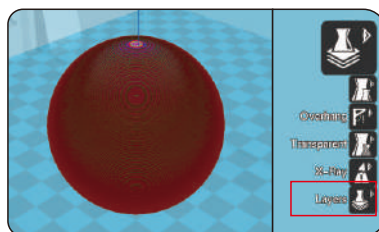

By slice view can easily observe the generated path, you can easily observe the different layers of sliced by slicing altitude indicator, use Ctrl + arrow keys can also be observed layer-by-layer.

Software Operation

Model Rotate

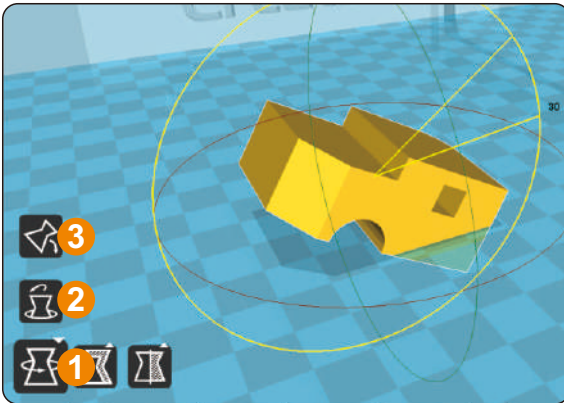

Click on the left corner of the rotate button [1], you can see three ring line around the model, respectively along the X, Y, Z direction. The default rotation angle is 5 degrees, press the Shift key can restrict the rotation angle to 1 degree.

Button [2] is the reset button, can restore rotate status to the default state.

Button [3] is lay flat button, can lay the model flat on the platform automatically.

Model Scale

Click the left corner of the zoom button [1], you can see a contour line around the model, and shows the current size of the model. You can input the value of the zoom ratio in Scale X / Y / Z, may also directly enter the size you need. Button [4] indicates locking scaling.

Button [2] is zoom reset button, you can restored the model to the default size.

Button [3] for the zoom model size to the maximum print size.

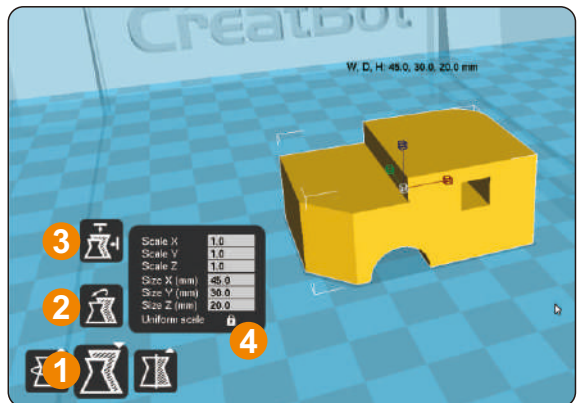

Software Operation

Right Click on Model

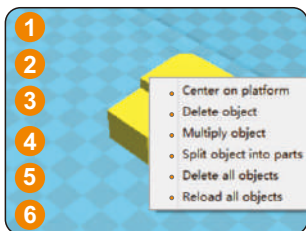

Right-click on the model pop-up shortcut menu, here are more features:

[1] "Centered" make the model back to the center position of the platform. [2] "Delete" to remove the currently selected model. [3] "Multiply" to copy the currently selected model and automatically position, which is useful for printing more than one model at a time. [4] "Split" multi-component model can be split into its separate components, this process more time-consuming, try to split the model in the modeling software, models splitted can be printed individually and then assembled together. [5] "Delete All" to delete all the models loaded. [6] "Reload all" Reload all models, same as F5.

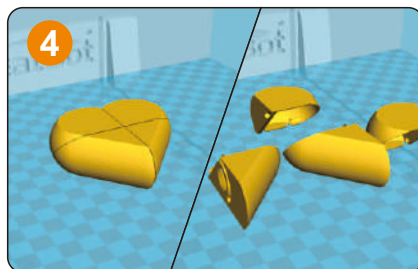
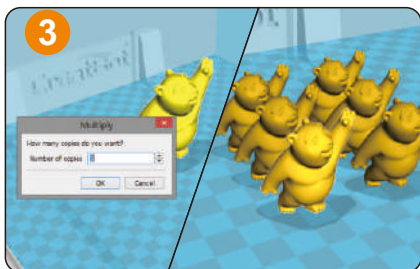

Toolpath Structure

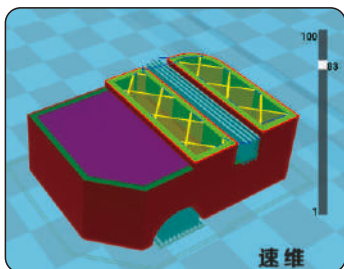

- Red represents "outer shell"
- Yellow represents "infill"
- Green represents "inner shell"
- Blue represents "support"
- Purple represents "bottom and top shell"

Drag layer indicator can browse different level paths, Ctrl + arrow keys to browse layer by layer. 3D printing is the superposition of these different layers and built layer by layer.

Software Operation

Basic Setting

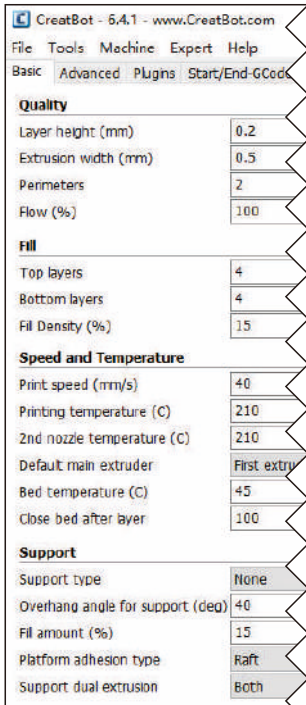

Layer height: This is the most important setting to determine the quality of your print, maximum value not exceed 80% of the nozzle diameter.

Shell thickness: Refers to the total thickness of the inner and outer walls, the outer wall is only one, the inner wall can be more, set this value to an integer multiple of the diameter of the nozzle.

Flow: Refer to the amount of printing material, 100% standard dosage, the more material the model prints more plump.

top/bottom thickness: Is the thickness of the upper and lower models, usually a multiple of layer height.

Fill density: Control how density filled the insides of your print will be, a value around 20% is usually enough, 0% for hollow.

Print speed: Speed at which printing happens. Print speed is affected by many factors, it is recommended to use low speed for complex model, high speed will cause the feed shortage, need improve nozzle temperature to compensate.

Nozzle temperature: Is the melting temperature of filament, general use 200°C for PLA and 240°C for ABS.

Bed Temperature: General use 45°C for PLA and 70°C for ABS.

Default main head: The default is the first nozzle, can also be set to other nozzles, this can reduce the times of changing filament.

Support type: The touching build plate support type is shown in figure [A], everywhere support is shown in figure [B].

Support angle: The larger the angle, the more support generate.

Fill amount: The larger the fill, the more support generate.

Platform adhesion type: The model which is not easy adhesion

on the platform please use Brim, which is easy to warped or ABS filament please use Raft.

Support Type

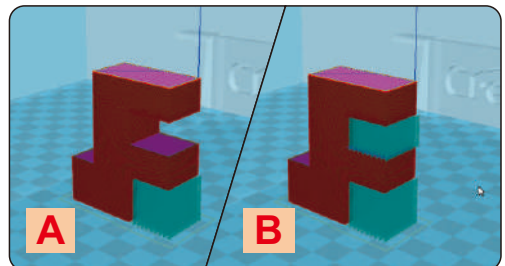

Software Operation

Advanced Setting

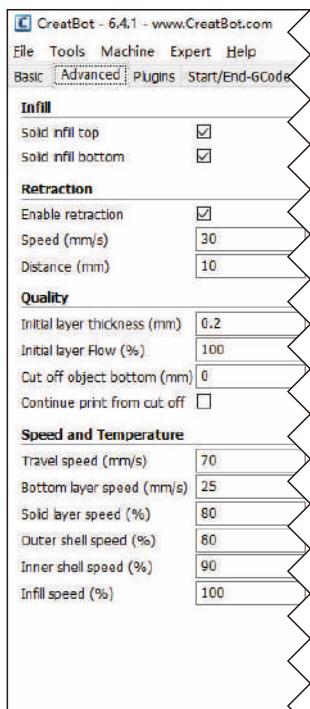

Solid fill top: Refers to whether to print the top surface of the model, uncheck will print it with infill method.

Solid fill bottom: Same as above, and so on.

Spiralis print: Refers to the method of spiral printing the outer wall of the model (single layer), and this feature is very suitable for print glass vase model.

Enable retraction: When the nozzle is moving over a non-printed area, withdraw a certain length length filament to prevent overflow.

Retract speed: The speed of retraction, too fast can lead motor out of step, too slow increase printing time.

Retract distance: The length of the filament when enable retraction.

First layer thickness: Height of the first layer of printing, generally greater than 0.15mm. □

First layer flow: When the set of the first layer is too high, it can be appropriate to increase the extrusion.

Cut off object bottom: This can be used for objects that do not have a flat bottom.

Continue print: Being "power outages continued" be substituted.

Travel speed: The speed when moving over a non-printed area.

First layer speed: Slightly slow speed can enhance adhesion

model on the platform.

Solid layer speed: The speed is a percentage here, which reference to the global print speed, a combination of different speeds, you can both get a good print quality and a faster print time.

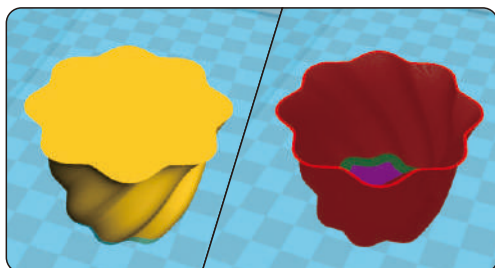

Spiralise Printing

Software Operation

Export Setting

Nozzle size: Set the nozzle size.

Diameter: Accurate measurement of your filament gives better quality prints.

Minimum travel: The minimum distance which can trigger filament retract.

Minimum extrusion: The minimal amount of extrusion that needs to be done before retracting.

Enable combing: Combing is the act of avoiding holes in the print for the head to travel over.

Wipe tower: Is a small tower next to your print where the nozzle wipes itself clean when switching nozzles.

Dual extrusion switch amount: Amount of retraction when switching nozzle with dual-extrusion, a value of 15mm seems to generate good results.

Cooling fan: The extra cooling fan is essential while printing small model, but when print ABS material, the max fan speed should not more than 50%.

Skirt: The skirt is a line drawn around the model at the first layer. This helps to prime your extruder, and to see if the model fits on your platform.

Brim: The amount of lines used for a brim, more lines means a larger brim which sticks better.

✕

Expert config

Nozzle		Cool	
Nozzle size (mm)	<input type="text" value="0.4"/>	Enable cooling fan	<input checked="" type="checkbox"/>
Filament		Minimal layer time (sec)	<input type="text" value="5"/>
Diameter (mm)	<input type="text" value="3.0"/>	Fan full on at height (mm)	<input type="text" value="0.0"/>
Diameter2 (mm)	<input type="text" value="3.0"/>	Fan speed min (%)	<input type="text" value="100"/>
Retraction		Fan speed max (%)	<input type="text" value="100"/>
Minimum travel (mm)	<input type="text" value="2"/>	Minimum speed (mm/s)	<input type="text" value="10"/>
Minimal extrusion before retracting (mm)	<input type="text" value="0.02"/>	Cool head lift	<input type="checkbox"/>
Z hop when retracting (mm)	<input type="text" value="0"/>	Support	
Enable combing	<input type="text" value="All"/>	Structure type	<input type="text" value="Lines"/>
Dual extrusion		Distance X/Y (mm)	<input type="text" value="1"/>
Wipe&prime tower	<input type="checkbox"/>	Distance Z (mm)	<input type="text" value="0.1"/>
Tower volume per layer (mm3)	<input type="text" value="15"/>	Brim	
Ooze shield	<input type="checkbox"/>	Brim line amount	<input type="text" value="5"/>
Dual extrusion overlap (mm)	<input type="text" value="0.1"/>	Raft	
Dual extrusion switch amount (mm)	<input type="text" value="15"/>	Extra margin (mm)	<input type="text" value="5"/>
Infill		Line spacing (mm)	<input type="text" value="3.0"/>
Infill overlap (%)	<input type="text" value="10"/>	Base thickness (mm)	<input type="text" value="0.3"/>
Infill prints after perimeters	<input checked="" type="checkbox"/>	Thickness (mm)	<input type="text" value="0.25"/>
Black Magic		Airgap (mm)	<input type="text" value="0.2"/>
Spiralize the outer contour	<input type="checkbox"/>	Layers	<input type="text" value="3"/>
Only follow mesh surface	<input type="checkbox"/>	Fix horrible	
Skirt		Combine everything (Type-A)	<input checked="" type="checkbox"/>
Line count	<input type="text" value="1"/>	Combine everything (Type-B)	<input type="checkbox"/>
Start distance (mm)	<input type="text" value="3"/>	Keep open faces	<input type="checkbox"/>
Minimal length (mm)	<input type="text" value="260"/>	Extensive stitching	<input type="checkbox"/>
<input type="button" value="Ok"/>			



Notice: Most of the setting have been optimized, If you want restore default configuration, use the menu "Tools" -> "Reset profile to default".

Software Operation

Skirt · Brim · Raft

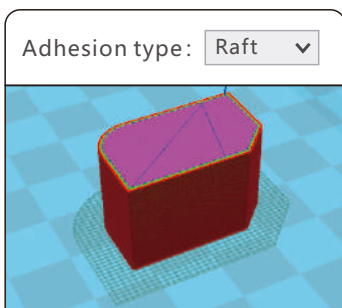
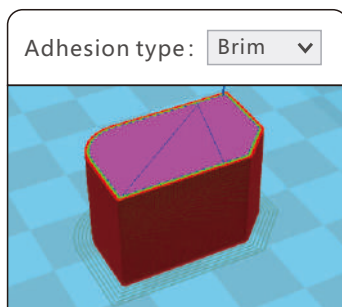
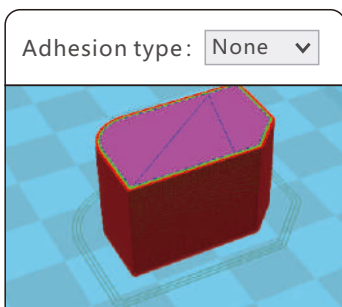

Plugin enable you to easily include your own features, without having to modify the source code or Gcode. In the screen shot above, these can be enabled by clicking on the arrow down button, then you can configure the plugin.



Notice: Please remove the plugin before you close the software.

Plugins

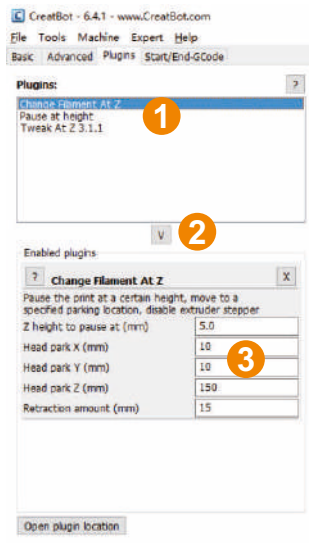

Software Operation

Start / End GCode

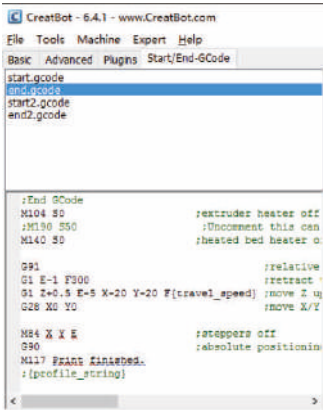

The start and end code are the startup and end procedure of the print, editing this requires knowledge of GCode.

If you want to set the automatic heating station after printing, you can remove the ";" in the code ";M190 S50".

start.gcode is the start code of single extruder, start2.gcode is the start code of double extruder, and so on.

Dual Head Printing

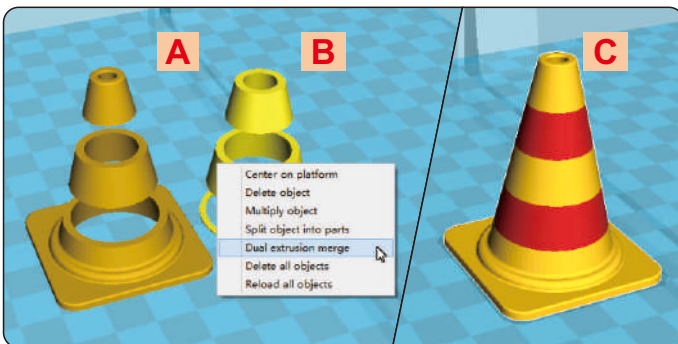

Step 1: Load 2 models you want as shown in figure [A] and [B].

Step 2: First click [A], then right click on [B], you will get the option: dual extrusion merge, this will merge both models into

one model [C].

Step 3: Set parameters like ordinary single color model and save the GCode.



Tip: The model select first will print by main extruder, the right clicked one by second extruder.

Software Opertation

Align Dual Head Vertical



Step 1: loose the screws on the back.

Step 2: raise or lower hotend with heads after cooling nozzle

Step 3: Lower left nozzle step by step same with right nozzle.

(Note: every time you raise or lower nozzle, you need to adjust the offset value in autoleveling menu)



Tip: You can rising right nozzle as long time not use.

Add Multi Type Printer

You can add more than one type of CreatBot to the software, and easily switch between them without re-config all the different machine

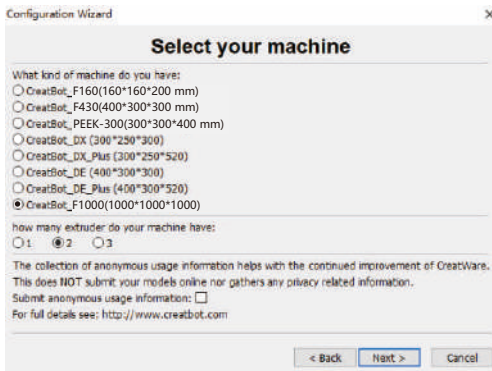
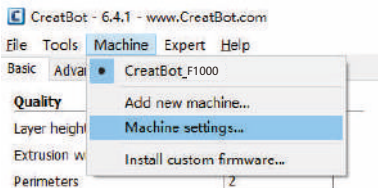

Software Operation

Align Dual Head Horizontal

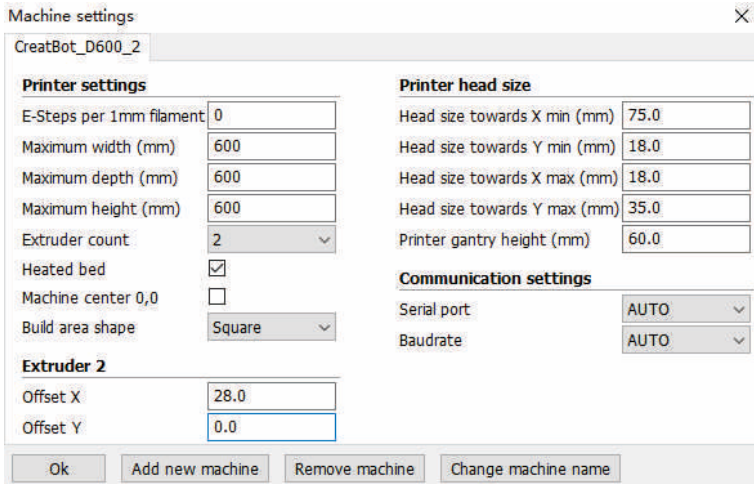

There are alignment problem while printing dual color model, this is because the small difference in multi-nozzle assembly, CreatWare built fine-tuning features.

Click menu "Machine">"Machine settings", default X offset is: 20.0, default Y offset is: 0.0, adjustment method as shown below:

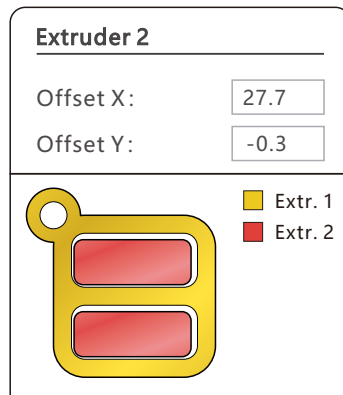
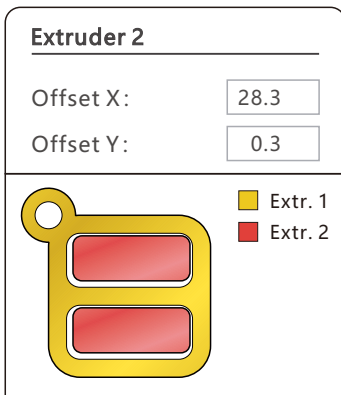

Software Opertation

Print Setting Of Different Filament

	Nozzle temperature	Hot bed	Plantform adhesion type	Fully enclose or not
PLA	190~210°C	None/45°C	None/Raft	Can open
ABS	240~250°C	90°C	Brim/Raft	Enclosed
Nylon	240~270°C	100°C	Brim/Raft	Enclosed
HIPS	230~260°C	100°C	None/Brim	Enclosed
PETG	230~260°C	100°C	None/Brim	Enclosed
Flexible	210~230°C	None/45°C	None	Can open
Wood	190~220°C	None/45°C	None	Can open
PC	230~260°C	100°C	Brim	Enclosed
PEEK	380~430°C	Bed 120°C/Air 70°C	Raft	Enclosed

* The data is only for reference, different environmental data will be different. F160 and F430 can print PEEK.

Frequently Asked Questions

Hardware Troubleshoot

1. Display "MINTEMP" ?

The environment is too low, or temperature sensor is damaged, please keep the room temperature above 0°C.

2. Display "MAXTEMP" ?

Temperature of nozzle or bed too high, or temperature sensor is damaged, please keep their temperature in a suitable range.

3. USB connection problems ?

Please specify the correct port and baud rate (250000), or change a shorter USB cable.

4. Nozzle heats up too slowly ?

Temperature in door is too low, or use a fan duct, or turn up output voltage (24.5v).

5. Print head stuck ?

Clean the guide rail and add lubricating oil.

6. Print head can not move ?

Stepper motor chipset burned, or belt damaged, or belt wheel screw loose.

7. Print head hit the framework ?

Corresponding axis stop limit or circuit fault.

8. Unable to power on ?

Power switch is damaged or fuse is burned, and please check whether the power adapter is working properly or power check board is damaged.

Printing Troubleshoot

1. How to set the temperature of the nozzle ?

Different filament temperature is different, general as follows:

PLA temperature 190°C ~210°C, bed 45-60°C.

ABS temperature 230°C ~250°C, bed 80-100 °C.

You must leave enough time for filament heating, so the faster printing speed need the higher temperature, 60mm/s temperature need raise about 10°C. In the same way, larger thickness need higher temperature.

2. How to set the temperature of the hot bed ?

The main purpose of the hot bed is to prevent model wrapped, PLA need about 45°C and 70°C for ABS is enough, but due to the environment and filament, we often need to increase the temperature, the highest temperature

Printing Troubleshoot

not over 120°C, and you can close the bed above 100mm except printing ABS or other high-temperature required filaments.

3. The model not stick on the platform ?

Please paste masking paper or Kapton tape on the platform, or the nozzle is too far away from the platform, or the bottom of the model is not flat.

4. No or less silk coming on the first layer ?

The distance between nozzle and platform is too small, or the filament has not been sent to the nozzle.

5. Why nozzle is not spit silk ?

The filament is not pressed or too tight, or print temperature is too low, or the filament feeder not working.

6. How to prevent model become warped ?

Increase hot bed temperature or use Kapton, or change platform adhesion type to Raft, or cover the baffle, or reduce indoor ventilation.

7. How far from nozzle to platform appropriate ?

Distance should be 0 in theory, but there is no absolutely flat platform, so the distance should ± 0.1 mm. Finally, with the actual printing effect as the standard, too close will lead to a silk blocked, too far will cause the model not stick on the platform.

8. How to determine whether the temperature is too high ?

PLA temperature is too high will appear liquefaction, ABS will be the carbide, that will block the nozzle.

9. What reasons will causing nozzle blocked ?

Filament are impurities or print environment dust too much, bad of thermal conductivity between the nozzle and the heating block.

10. Model surface is loose with crack ?

The layer is too high or the printing speed too fast, nozzle temperature too low or filament press nut too loose, or filament is wrapped.

11. How to print a small model ?

Multiple the model, and print them at a time.

12. Dual color model not aligned ?

Adjust offset of second nozzle in machine settings.



13. Dual color model color interference ?

Align two nozzle in vertical direction





14. There is too much silk drag on the model ?

Please enable filament retraction, and specified proper retract speed, and distance, the retract distance should not less than 4mm, and the speed not less than 10mm/s.



Specifications

			
Model	F160	F430	D600
Build volume	160*160*200	400*300*300	600*600*600
Nozzles	Single	Single/Dual	
Diameter	0.4mm(0.3/0.6/0.8/1.0mm can be customized)		
Temperature	260(Max 420) °C		260 °C +420 °C
Nozzles Type	Direct		
Hot bed	140 °C	Bed 120 °C/Air 70 °C	100 °C
Min. Layer	0.04mm		
Accuracy	X、Y、Z axis 0.01mm		
Print Speed	120mm/s (inner/outer, top/bottom, fill, first layer speed can be set separately)		
Travel Speed	200mm/s		
Materials	ABS,PLA,TPU,PETG,HIPS,PVA, PA,PC,Carbon Fibre,PEEK,etc		
Fila. Diameter	1.75mm		3.0mm
Motion Structures	Optic axis		Rectilinear orbit
Auto Turnoff	Yes (pwr manager + relay)		
Continue Play	Yes (Power outage, lower plate and save data)		
Fila. Check	Yes (pause printing when filament finish, and lower platform)		
Adju. Head	Yes (height-adjustable-nozzles)		
OS	Windows, Linux, Mac OS, OSX		
Languages	Chinese, English multi-language		
Software	CreatWare Muti-language		
File Format	STL, OBJ, GCode, Amf		
Printing Field	Full closed covering		
Display	4.3 inches color touch screen		
Pwr Supply	110/220V 180W	110/220V 1300W	110/220V 1000W
Dimension	280*280*470mm	660*470*560mm	910*840*1100mm
Weight	22Kg	60Kg	170Kg

Specifications

				
Model	DX	DX Plus	DE	DE Plus
Build volume	300*250*300	300*250*520	400*300*300	400*300*520
Nozzles	Dual/Tris			
Diameter	0.4mm(0.3/0.6/0.8/1.0mm can be customized)			
Temperature	400°C			
Nozzles Type	print head/new print head			
Hot bed	120°C (can be closed after certain layers)			
Min. Layer	0.04mm			
Accuracy	X、Y、Z axis 0.01mm			
Print Speed	120mm/s (inner/outer, top/bottom, fill, first layer speed can be set separately)			
Travel Speed	200mm/s			
Materials	ABS,PLA,TPU,PETG,HIPS,PVA, PA,PC,Carbon Fibre,etc			
Fila. Diameter	3.0mm (1.75mm optional)			
Keypad	Yes (nine key)			
Auto Turnoff	Yes (pwr manager + relay)			
Continue Play	Yes (Power outage, lower plate and save data)			
Fila. Check	Yes (pause printing when filament finish, and lower platform)			
Adju. Head	Yes (height-adjustable-nozzles)			
OS	Windows, Linux, Mac OS, OSX			
Languages	Chinese, English multi-language			
Software	CreatWare Muti-language			
File Format	STL, OBJ, GCode, Amf			
Chipset	Atmega 2560-16AU (AVR 8 Bit 16MHz, 256KB Flash)			
Display	128*64 monochrome multi-language (support color TFT)			
Pwr Supply	110/220V 360W		110/220V 700W	
Dimension	420*380*570	420*380*790	590*430*570	590*430*790
Weight	35 Kg	40Kg	45Kg	55Kg

Specifications

		
Model	PEEK-300	F1000
Build volume	300*300*400mm	1000*1000*1000mm
Nozzles	Double	
Diameter	0.4mm(0.3/0.6/0.8/1.0mm optional)	1.0 mm (0.4~1.5 mm)
Temperature	Max 500°C	Max 420°C
Hot bed	Max 200 °C	Max 100°C
Min. Layer	0.05mm	0.05mm
Accuracy	X.Y0.011mm;Z 0.025	X.Y0.011mm;Z 0.025
Print Speed	10-150 mm/s	10-120 mm/s
Materials	ABS,PLA,Carbon Fiber,PETG,Nylon,PC,etc.	
Fila. Diameter	1.75 mm	
Auto Turnoff	Yes (pwr manager + relay)	
Continue Play	Yes (Power outage, lower plate and save data)	
Fila. Check	Yes (pause printing when filament finish, and lower platform)	
Adju. Head	Yes (height-adjustable-nozzles)	
OS	Windows, Linux, Mac OS, OSX	
Languages	Chinese, English	
Software	CreatWare Muti-language	
File Format	STL, OBJ, GCode, Amf	
Chipset	Atmega 2560-16AU (AVR 8 Bit 16MHz , 256KB Flash)	
Display	4.3 inches color touch screen	9.7 inches color touch screen
Pwr Supply	110-220v 3000W	220~240 V, 50~60 Hz;4000W
Dimension	650*600*750 mm	1910*1510*2205mm
Weight	100 kg	640 kg



Quality · Experience · Service

Henan Suwei Electronics Technology Co., Ltd.

Telephone: +86 4000-558-930

Website: www.CreatBot.com

Email: sales@creatbot.com

Address: 6#, Chaoya Industry Park, Hanghai Road,
No.13 Ave., Eco-Tech Development Zone,
Zhengzhou City, Henan Province, China